



6 ASSI 6 AXIS



ASSE A - AXIS A



ASSE A - AXIS A



ASSE K - AXIS K



ASSE C - AXIS C











ASSE C - AXIS C



ASSE C - AXIS C



MANTA NEW POKER 12

MOD.	 mm	 RPM	 kW - Volt	 mm	 mm	 mm	 mm	 cm (L-B-H)	 Kg
MANTA NEW POKER 12	450	560 ÷ 2800	8 - 400	3200	2000	250	125	480x270x215	1950 ca
VOLTAGGIO E POTENZA A RICHIESTA - VOLTAGE AND POWER UPON REQUEST - VOLTAJE Y POTENCIA SEGUN DESEO SPANNUNG UND LEISTUNG NACH ANFRAGE - VOLTAGE ET PUISSANCE SUR DEMANDE									

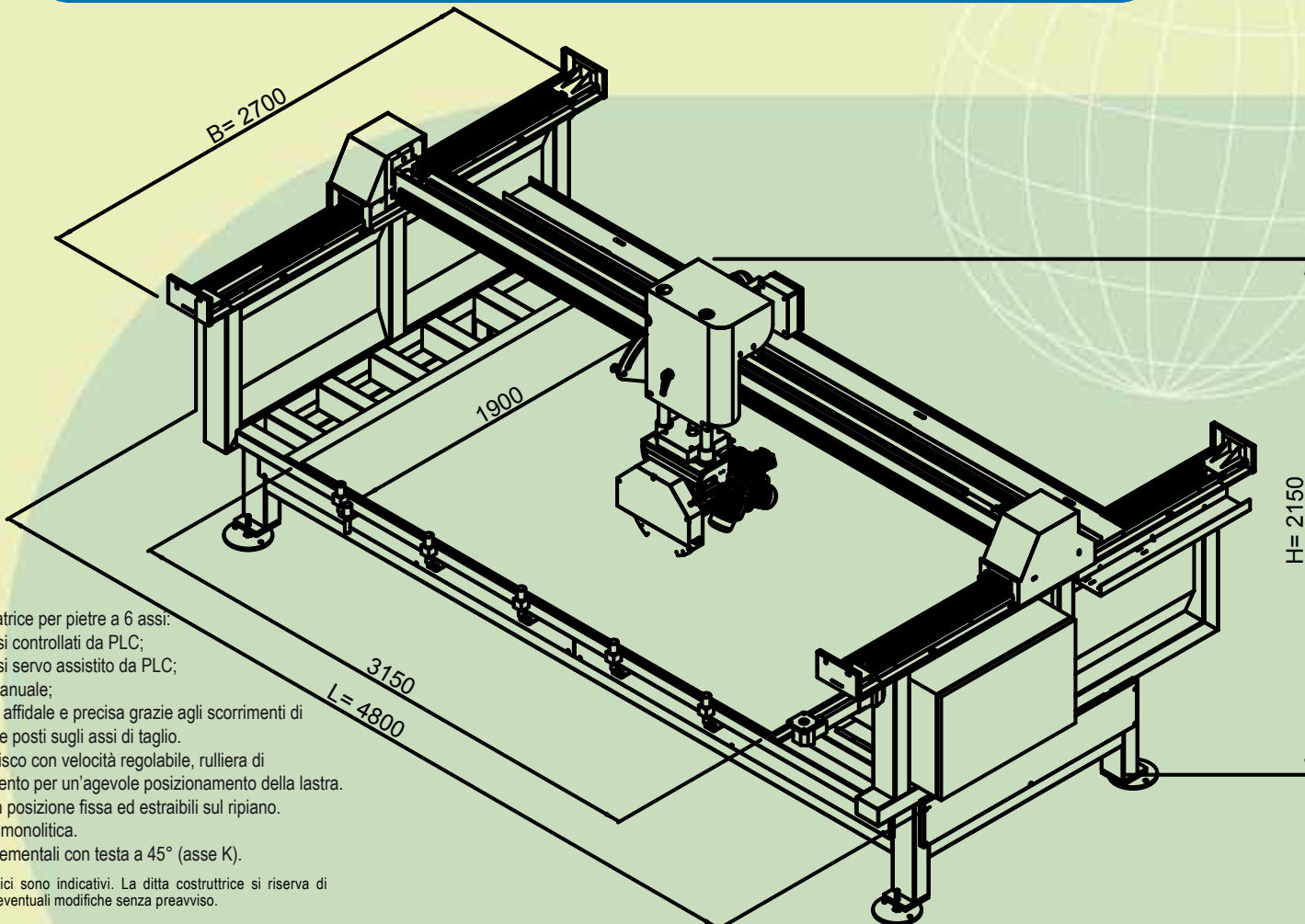

Segatrice per pietre a 6 assi:
3 assi controllati da PLC;
2 assi servo assistito da PLC;

1 asse manuale;

Robusta, affidabile e precisa grazie agli scorrimenti di precisione posti sugli assi di taglio.

Motore disco con velocità regolabile, rulliera di sollevamento per un'agevole posizionamento della lastra.

Battute in posizione fissa ed estraibili sul ripiano.

Struttura monolitica.

Tagli incrementali con testa a 45° (asse K).

I dati tecnici sono indicativi. La ditta costruttrice si riserva di apportare eventuali modifiche senza preavviso.



6-axis saw for stone :

3-axis controlled by PLC;

2-axis servo assisted by PLC;

1 manual axis;

Robust, trustworthy and precise machine due to precision sliding placed on cut axis.

Blade motor with adjustable speed, pop up rollers for an easy slabs positioning.

Stops in fixed position removable from the machine bench.

Monolithic structure.

steps cut facility with head at 45° (K axis).



6-Achsen Schneidemaschine für Steine :

3-Achsen sind vom PLC kontrolliert ;

2-Achsen sind vom PLC unterstützt;

Eine Achse ist manuell;

Robust, zuverlässig und präzise Maschine durch präzise Ableitung auf den Schnitt-Achsen.

Blatt-motor mit einstellbarer Geschwindigkeit, Aufheben Rollen für einfachen Positionierung der Platte.

Anschlage in einer festen Position, die vom Maschinentisch abgenommen werden.

Monolithischen Struktur.

Inkrementale Schnitte mit Kopf 45° (K Achse).



Débiteuse pour la pierre à 6 axes:

3-axes sont contrôlés par PLC;

2-axe sont servo assistés par PLC;

1 axe est manuel;

Machine robuste, fiable et précise grâce à précis sièges coulissant placés sur les axes de coupe.

Disque moteur à vitesse réglable, système intégré à rouleaux de levage pour faciliter le placement de la plaque.

Butées à position fixe qui peuvent être enlevés de la table de la machine.

Structure monolithique.

Incrémentation de passe avec tête à 45° (axe K).



The above technical data are informative only and are in no way binding. The manufacturer reserves the right to modify machine without prior notice.

Technische Angabe sind inkativ. Änderungen ohne vorankündigung vorbehalten.

La maison Nuova Mondial Mec srl se réserve le droit d'apporter des modifications par suit d'exigences techniques.



NUOVA MONDIAL MEC Srl

via la pastora, 82 - Cerasolo di Coriano

47853 Rimini Italy

Tel. +39 0541 75 96 88 - Fax +39 0541 75 62 38

www.nuovamondiamec.com

info@nuovamondiamec.com