









RICAMBI • SPARE PARTS PIECES DETACHEES • ERSATZTEILE

Art.		
	MARTINETTO JACK VERIN HEBEBOCK	
225	x artt. 2-3-3ST-3STR	V/1
226	x art. 4H	V/1
	RUOTA WHEEL ROUE RAEDER	
301	x artt. 2-2J-3-3ST-3STR	V/1
302	x art. 4H	V/1
	MOLLA SPRING RESSORT FEDER	
216S	x art. 3-3S-3STR	V/1
217	x art. 4H	V/1
220	x artt. 2-2J	V/1

Art.		
	COPPIA LAMIERE METAL SUPPORT TABLES TOLES PAAR STAHLBLECHE	
309	x art. 4H	V/1
	POMOLO ADJUSTMENT SCREW POMMEAU EINSTELLSCHRAUBE	
209	x art. 4H	V/1
	COPPIA LAME BLADE SETS PAIRE DE LAMES MESSERPAAR	
199	x artt. 2-2J	V/1
200	x art. 3	V/1
200S	x art. 3ST	V/1
206STR	x art. 3STR	V/1
205	x art. 4H	V/1



RICAMBI • SPARE PARTS
PIECES DETACHEES • ERSATZTEILE

Art.		
	MARTINETTO JACK VERIN HEBEBOCK	
225A	x artt. 3A-3STRA	V/1
	COPPIA LAME BLADE SETS PAIRE DE LAMES MESSERPAAR	
200	x art. 3A	V/1
206STR	x art. 3STRA	V/1
	MOLLA SPRING RESSORT FEDER	
216S		V/1



RICAMBI • SPARE PARTS
PIECES DETACHEES • ERSATZTEILE

Art.		
	COPPIA TAMPONI PAD SETS PAIRE DE LAMES MESSERPAAR	
306	x art. 16	B/1
306-40	x art. 16-40	B/1





HYDROTRONK

TRONCALASTRE IDRAULICO • HYDRAULIC SLAB CUTTERS
DÉCOUPEUSE HYDRAULIQUE • HYDRAULISCHER PLATTENSCHNEIDER



Art. 3STR



Art. 4H



Art.							
	cm	inch	cm	inch	kg	kg	
3STR	61	24	8,5 ÷ 23,5	3 1/4 ÷ 9 1/4	25.000	124	V/1
4H	41	16	2 ÷ 15,5	3/4 ÷ 6 1/8	10.000	55	V/1



FAST HYDROTRONK

TRONCALASTRE IDROPNEUMATICO • HYDROPNEUMATIC SLAB CUTTERS
DÉCOUPEUSE HYDROPNEUMATIQUE • HYDROPNEUMATISCHE PLATTENSCHNEIDER

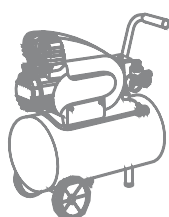

MINIMUM
20 lt - 6 bar

Art. 3STRA



Art.							
	cm	inch	cm	inch	kg	kg	
3A	51	20	1 ÷ 16	3/8 ÷ 6 1/4	25.000	108	V/1
3STRA	61	24	8,5 ÷ 23,5	3 1/4 ÷ 9 1/4	25.000	124	V/1



PINZONI

PINZE DI SOLLEVAMENTO PER CORDOLI • KERB STONE HANDLES
PINCES MANUELLE POUR LA POSE DE BORDURES • BORDSTEINZANGE ZUM SETZEN VON BORDSTEINEN

Art. 16









Art. 16-40



Art.			PORTATA MAX MAX LOAD		
	cm	inch	kg	kg	
16	8 ÷ 18	3 1/8 ÷ 7 1/8	200	11	C/1
16-40	18 ÷ 40	7 1/8 ÷ 16	300	18,3	C/1

RICAMBI • SPARE PARTS PIECES DETACHEES • ERSATZTEILE

Art.		Art.	
	COPPIA LAME BLADE SETS PAIRE DE LAMES MESSERPAAR		MOLLA SPRING RESSORT FEDER
208R	V/1	217L	V/1
	LAMIERA METAL SUPPORT TABLE TOLE STAHLBLECHE		
308	V/1		
	POMOLO ADJUSTMENT SCREW POMMEAU EINSTELLSCHRAUBE		RUOTA WHEEL ROUE RAEDER
209	V/1	302	V/1



RICAMBI • SPARE PARTS
PIECES DETACHEES • ERSATZTEILE

Art.	
	COPPIA LAME BLADE SETS PAIRE DE LAMES MESSERPAAR
205	x artt. 4-4KKS V/1
205L	x art. 4L V/1
206	x art. 8 V/1
206S	x artt. 8K-8KS-8KKS V/1
208	x art. 6-6KS-6KKS V/1
208L	x art. 6L V/1
	MOLLA SPRING RESSORT FEDER
217	x artt. 4-4KKS-6-6KS-6KKS V/1
217L	x artt. 6L V/1
218L	x art. 4L V/1
218	x artt. 8-8K-8KS-8KKS V/1
	COPPIA LAMIERE METAL SUPPORT TABLES TOLES PAAR STAHLBLECHE
309	x artt. 4-4KKS V/1
	RUOTA WHEEL ROUE RAEDER
301	x artt. 8-8K-8KS-8KKS V/1
302	x artt. 4-4KKS-4L-6-6KS-6KKS-6L V/1
	POMOLO ADJUSTMENT SCREW POMMEAU EINSTELLSCHRAUBE
209	x artt. 4-4KKS-4L-6-6KS-6KKS-6L V/1
214	x artt. 8-8K-8KS-8KKS V/1
art. 305 	MANIGLIA / FERMAGLIO HANDLE / CLIP POIGNEE / FERMOIR GRIFF / KLAMMER
305	x artt. 4-4KKS-6-6KS-6KKS-8-8K-8KS-8KKS V/1
307	x artt. 4-4KKS-6-6KS-6KKS-8-8K-8KS-8KKS V/1





REVOLVER

TRACIABLOCCHETTI • PAVING BLOCK CUTTERS • DÉCOUPEUSE À DALLES ET À PAVÉ • GEHWEG-PLATTENSPALTER



Art.								
	cm	inch	cm	inch	kg	kg	C/1	
6R	31	12	0 ÷ 12,5	0 ÷ 5	4.100	45	C/1	



TRACIABLOCCHI • PAVING BLOCK CUTTERS
DÉCOUPEUSE À DALLES ET À PAVÉ • GEHWEG-PLATTENSPALTER

**NEW
MODEL**



Art. 4







Art. 6L



Art. 4L

Art.								
	cm	inch	cm	inch	kg	kg	V/1	
4	41	16	2 ÷ 15,5	3/4 ÷ 6 1/8	4.100	60	V/1	
4KKS	41	16	10 ÷ 23	4 ÷ 9	4.100	67	V/1	
4L	41	16	0 ÷ 10	0 ÷ 4	4.100	45	C/1	
6L	31	12	0 ÷ 10	0 ÷ 4	4.100	29	C/1	
8KS	62	24	13 ÷ 23	5 ÷ 9	4.100	122	V/1	

RICAMBI • SPARE PARTS PIECES DETACHEES • ERSATZTEILE

Art.			Art.		
	COPPIA LAME BLADE SETS PAIRE DE LAMES MESSERPAAR			MOLLA SPRING RESSORT FEDER	
201	x art. 5	V/1	221	x art. 5	V/1
202	x art. 7	V/1	222	x art. 7	V/1
202N	x art. 7N	V/1	222N	x art. 7N	V/1
203	x art. 9	V/1	223	x art. 9	V/1
203N	x art. 9N	V/1	223N	x art. 9N	V/1
204	x art. 11	V/1	224	x art. 11	V/1
	POMOLO ADJUSTMENT SCREW POMMEAU EINSTELLSCHRAUBE				
210	x art. 5	V/1			
211	x art. 7	V/1			
212	x art. 9	V/1			
213	x art. 11	V/1			

OPTIONAL







TAVOLINO DI SUPPORTO
SUPPORT TABLE
TABLE DE SUPPORT
STÜTZTISCH



Art. 190



RICAMBI • SPARE PARTS PIECES DETACHEES • ERSATZTEILE

Art.			Art.		
	COPPIA LAME BLADE SETS PAIRE DE LAMES MESSERPAAR			MOLLA SPRING RESSORT FEDER	
207		V/1	217		V/1
	POMOLO ADJUSTMENT SCREW POMMEAU EINSTELLSCHRAUBE			RUOTA WHEEL ROUE RAEDER	
228		V/1	302		V/1
				FERMAGLIO CLIP FERMOIR KLAMMER	
			307		V/1



RICAMBI • SPARE PARTS
PIECES DETACHEES • ERSATZTEILE

Art.		
	COPPIA LAME BLADE SETS PAIRE DE LAMES MESSERPAAR	
270	x art. 32	B/1
271	x art. 42	B/1
	COPPIA MOLLE SPRING SETS PAIRE DE RESSORTS FEDERPAAR	
215	x art. 42	B/1
	MOLLA SPRING RESSORT FEDER	
364	95mm x art. 32	B/1





TRANCIAMARMETTE UNIVERSALE • TERRAZZO/MARBLE FLOOR TILE CUTTERS
 DÉCOUPEUSE UNIVERSELLE • UNIVERSAL-PLATTENSCHNEIDER

Art. 11



Art. 9N



Art.							
	cm	inch	cm	inch	kg	kg	
7N	41	16	0,5 ÷ 4,2	1/8 ÷ 1 5/8	1.000	30	C/1
9N	51	20	1,2 ÷ 5,5	0,5 ÷ 2	1.000	43	C/1
11	61	24	1,5 ÷ 6,5	5/8 ÷ 2,5	1.000	61	C/1



TRANCIAGESSO UNIVERSALE • UNIVERSAL PLASTER CUTTERS
 DÉCOUPEUSE À CX PLATRE ET CX BRIQUE UNIVERSELLE • GIPSPLATTEN-SCHNEIDER



Art.							
	cm	inch	cm	inch	kg	kg	
12	72	28	4 ÷ 14	1,5 ÷ 5,5	2.000	68	V/1



TAGLIATEGOLE • ROOF TILE CUTTERS
 DÉCOUPEUSE A TUILES • DACHZIEGEL HANDSCHNEIDER

Art. 32



Art. 42



Art.			
		kg	
32	Per tegole in cotto - For clay roof tiles	2,4	V/1
42	Per tegole in cemento e cotto - For clay roof tiles and concrete	7,0	C/1

CUT KIT

CUTTER PER VETRO/PIASTRELLE/LASTRE SOTTILI • *CUTTER FOR GLASS/CERAMIC/LARGE FORMATS*
 CUTTER POUR VERRE/CERAMIQUE/CARREUX GRANDS FORMATS • *MESSER FÜR GLASS/KERAMIK/GROSSE FORMATE*



Art.			
25V		B/1	

TIRAMOLLA

VENTOSA PER PIASTRELLISTA • *SUCKER FOR TILE-LAYER*
 VENTOUSE POUR CARRELEUR • *SAUGNAPF FÜR FLIESEN*



Art.			
VT80		B/1	

KOPIA PROFILE

COPIA IL PROFILO DI OGGETTI DIFFICILI DA RIPORTARE SULLA PIASTRELLA PRIMA DEL TAGLIO
FOR COPYING THE OUTLINES OF KNOTTY THINGS TO TRANSFER ON THE TILES BEFORE CUTTING
 PERMETTILLO LE RELÈVEMENT DU PROFIL D'OBJECTS DE FORMES DIFFICILES ET DE LE REPORTER SUR LES CARREUX AVANT DE LES COUPER
PROFILKOPIERLEHRE ZUM EINFACHEREN UEBERTRAGEN VON KOMPLIZIERTEN MOTIVEN AUF DIE ZU BEARBEITENDE FLIESE

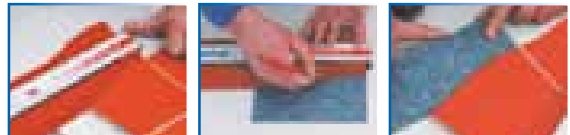

Art.			
60		V/1	

ERGO EVOLUTION

SUPPORTO-BANCO DA LAVORO PER PIASTRELLISTA
WORK-TABLE FOR TILE-LAYER
 TABLE DE TRAVAIL POUR CARRELEUR
ARBEITSTISCH FÜR FLIESENLEGER

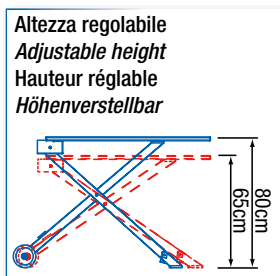

Art.				
994		21	C/1	